

Dept	Qty
DC	1
ED	1
IE	1
ISO	1
PD	1
R&D	1
SD	1
QA	1
QC	1
QF	1

The information provided herein is from CONNELY Electronic Co., Ltd. and is confidential. Any disclosure to a party other than the recipient is prohibited. The intellectual properties and its rights contained herein, including but not limited to, trademarks, patents, copyrights, trade secrets, and technical know-how, are owned exclusively by CONNELY or its affiliates. Unauthorized use or reproduction of any part of this document is strictly prohibited. CONNELY may enforce its intellectual property rights at its own discretion, failures or delays to exercise such rights does not constitute a waiver of such rights. Its use in any format or manner. CONNELY may enforce its intellectual property rights at its own discretion, failures or delays to exercise such rights does not constitute a waiver of such rights.

REV.	DESCRIPTION	DRAWN	CHECKED	APPROVED
A	NEW RELEASE	JLZ 03/16/15'	HZW 03/16/15'	LJC 03/16/15'
B	DRAWING UPDATE	JLZ 01/11/19'		

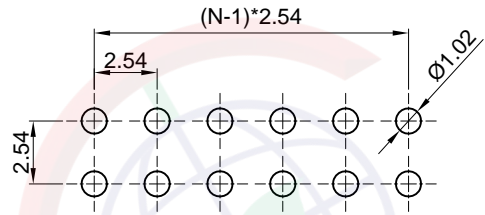
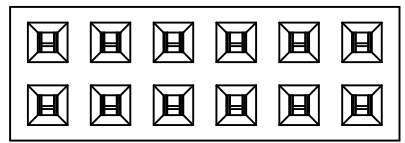
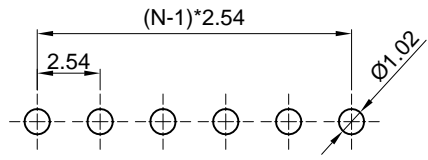
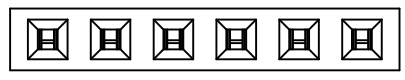

Recommend PCB layout  
(Tolerance:±0.05)

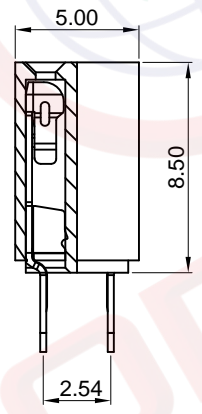
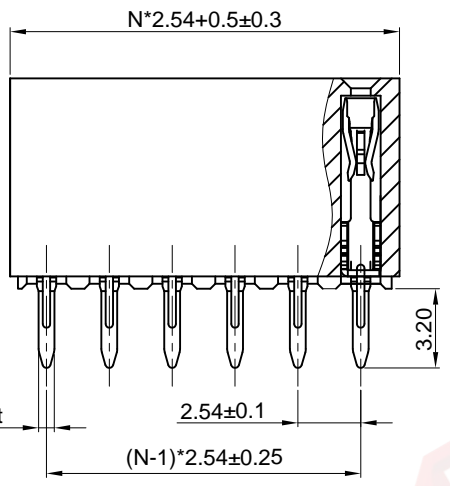

Double row  
N=No.of contacts/2

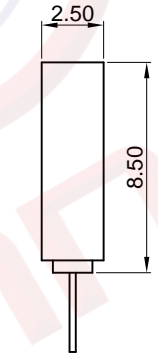

Single row  
N=No.of contacts

Notes:

- Specifications:
- Contact Resistance: 20mΩ Max.
  - Insulation Resistance: 1000MΩ Min.
  - Dielectric Withstanding Voltage: 600V AC(rms) For 1 Minute.
  - Current Rating:3A.
  - Temperature: -40°C--+105°C.

- Materials:
- Contact Material: Copper Alloy.
  - Contact Plating: Gold Plating Over Nickel.
  - Insulator Material: PBT,Black,UL94-V0.

Product Number Code:  
DS1023-33 - X X X

- Contact plating  
F1: Full glod flash
- Mounting type  
S: Straight type
- No.of contacts  
1x2 - 1x40  
2x2 - 2x40

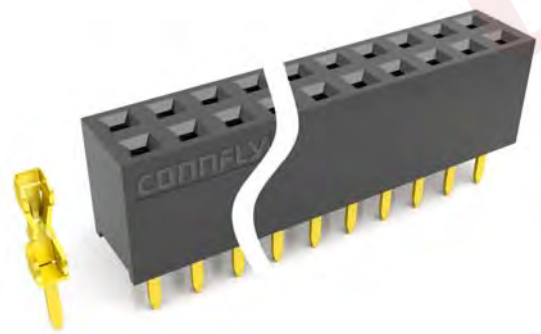

(Series Image-Reference Only)

GENERAL TOLERANCE		ANGLE TOLERANCE		PROJECTION		TITLE	2.54mm FEMALE HEADER V/T TYPE H=8.5mm	
X.	±0.60	X.	±5°	UNITS	mm	WITH HIGH O TYPE TERMINAL		
.X	±0.38	.X	±3°	SHEET SIZE	A4	SERIES	DS1023-33 SERIES	
.XX	±0.25	.XX	±2°	<b>晨翔电子有限公司</b> <b>CONNELY ELECTRONIC CO. LTD</b>				
DRAWING TYPE		CUSTOMER						
SCALE	1:1	SHEET	1 OF 1					
DRAWING NO.		C-DS1023-33-XXX-B						